

ARRIBA SE PUEDE CERRAR POR COMPLETO

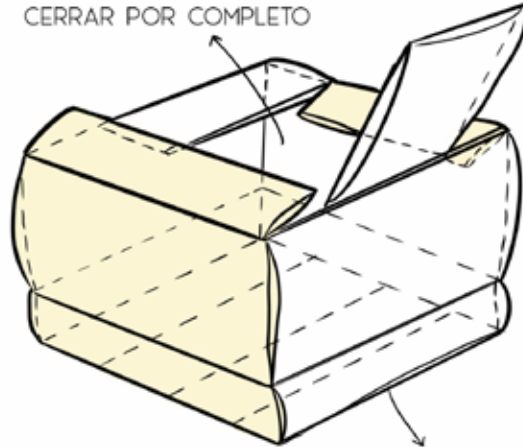

DOBLEZ

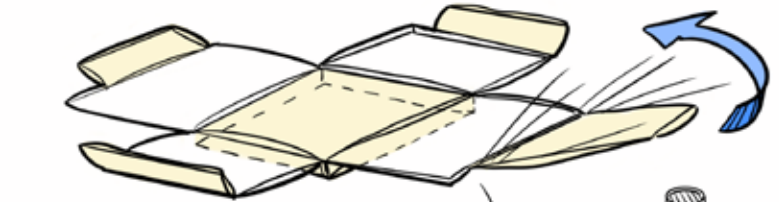

OTRA FORMA DE DOBLEZ

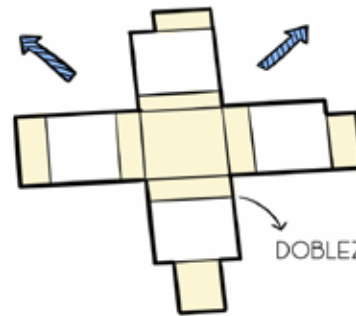

DOBLEZ



EMPACAR OBJETOS FRAGILES

SE JALAN LAS CINTAS PARA CERRAR

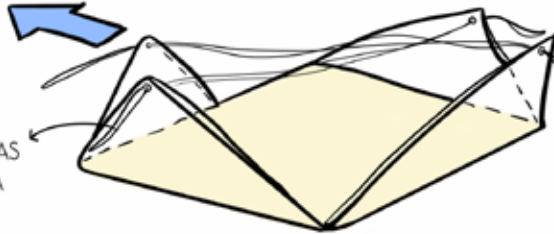

LINEA PUNTEADA: COSTURAS

CORTADO

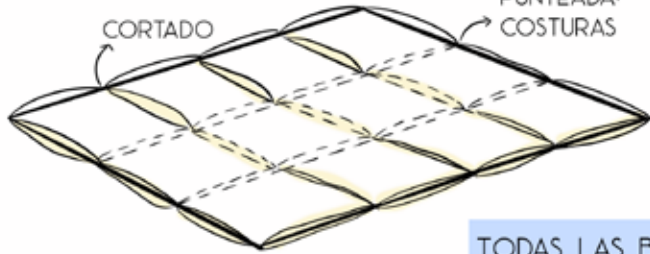

DOBLEZ

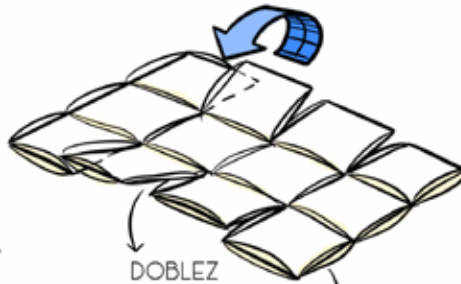

MODULAR CUADRADO

TODAS LAS BOLSAS ESTAN HECHAS DE TELA Y RELLENAS DE BOLSAS "PICADAS"

LOS DOBLECES SE ADAPTAN

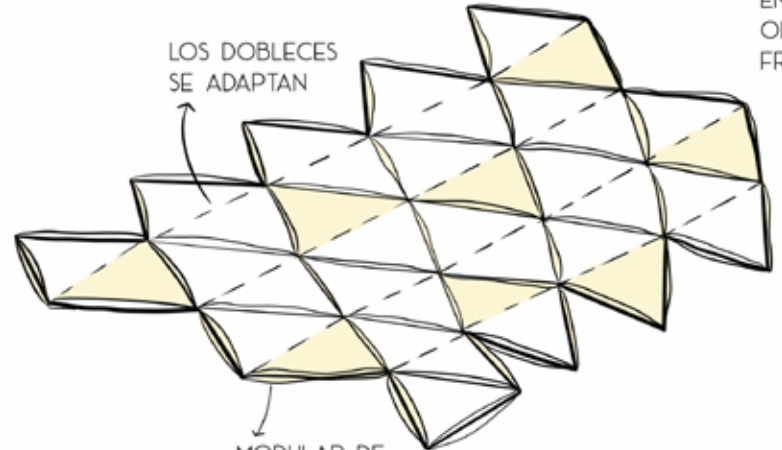

MODULAR DE TRIANGULOS

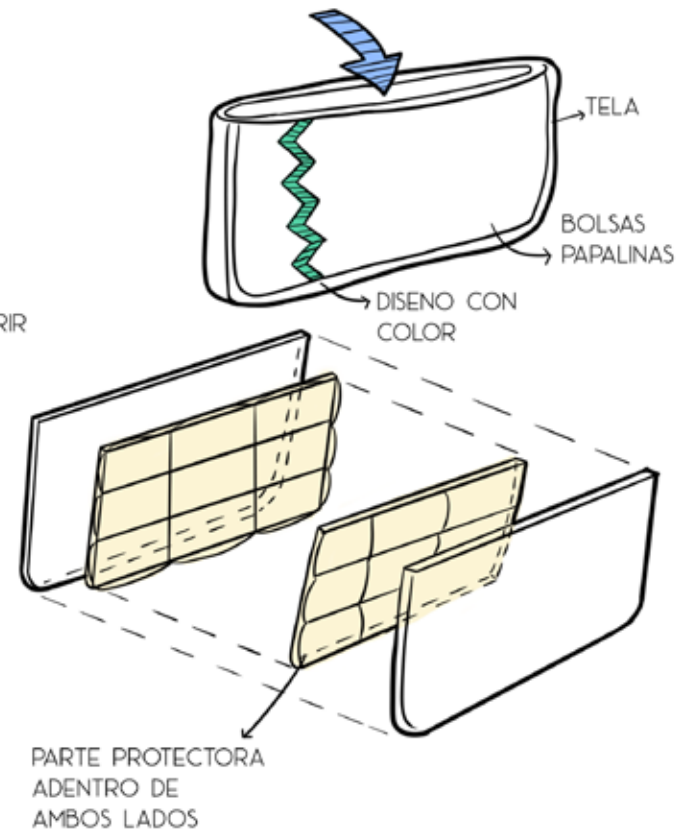
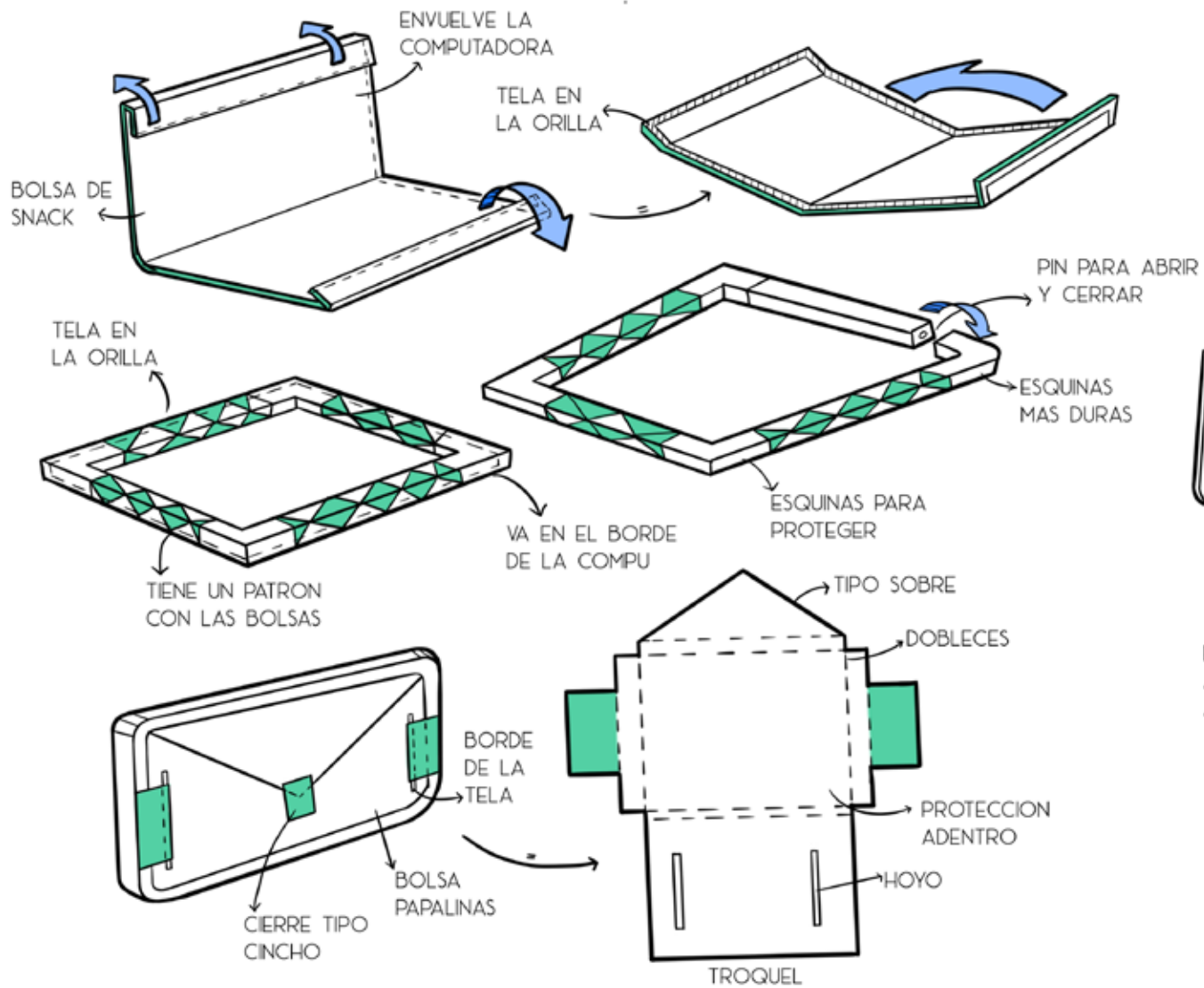

SE UTILIZA EL PROCESO DE PLANCHADO PARA GENERAR LAS SUPERFICIES

1) DIBUJAR PATRON

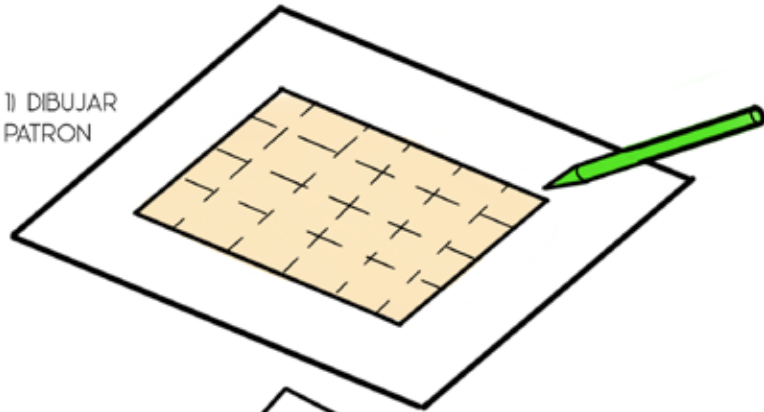

2) CORTAR PATRON
-2 POR PRODUCTO

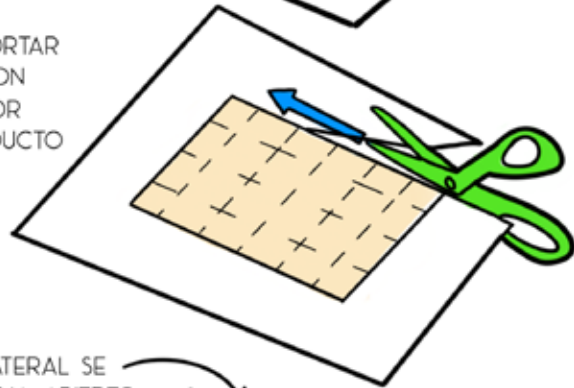

LATERAL SE DEJA ABIERTO

3) COSER BOLSA
-CON MAQUINA

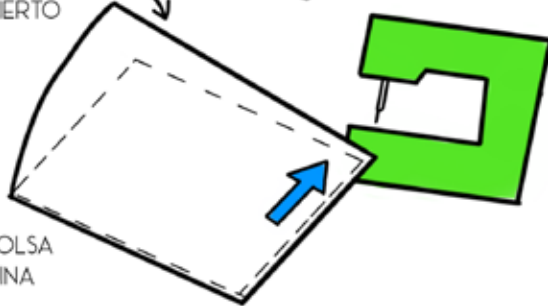

4) RELLENAR
CON MATERIAL
TRITURADO
(125-120 BOLSAS)

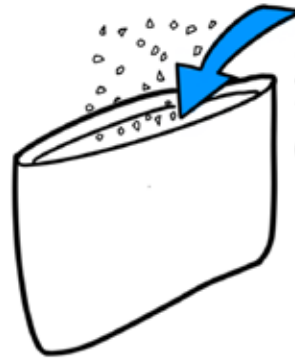

SEGUNDO
VERTICAL

PRIMERO
HORIZONTAL

5) COSER MODULOS
-CON AGUJA

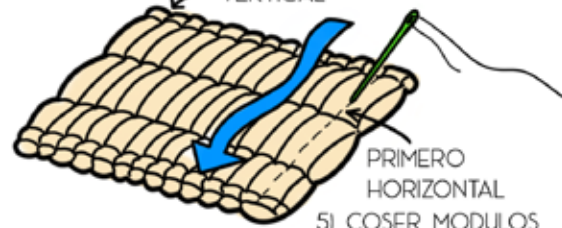

POR DENTRO

6) COLOCAR
CINTAS Y ELASTICO

ELASTICO

CINTA: SE DEJA
CERRADO

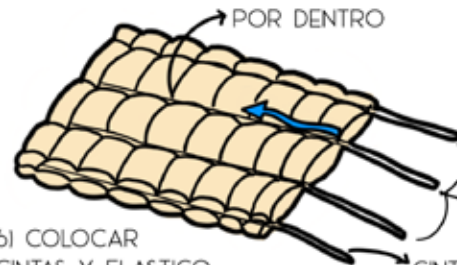

7) CERRAR BOLSA

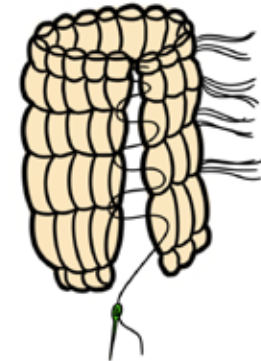

CINTA PARA
CARGAR

BOTON

BOTON PARA
AJUSTAR

8) AGREGAR
DETALLES

